

Wonder® Dog Costume

Delicious loaf or furry friend? With this Wonder Dog Costume, you'll need a double take to decide. Make it yourself with these easy steps.

Note: These instructions are not kid-friendly. Please ensure that only an adult is making this creation using these instructions, even if it is for a child.

Instructions

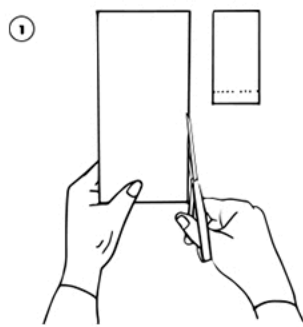

1 Cut the clear vinyl into a rectangle the length of your dog's back (neck to tail), plus an additional 15 cm at the tail end.

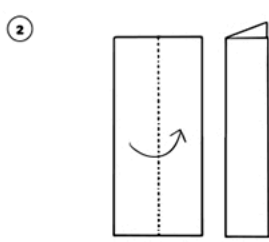

2 Fold the white vinyl material in half lengthwise.

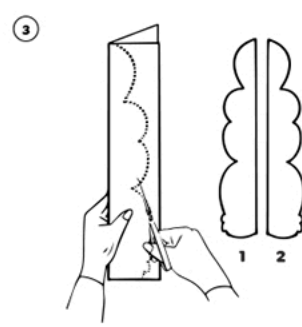

3 At the fold, cut a bubbly line like the reference image, then cut it at the folded base, so that you will have two white vinyl

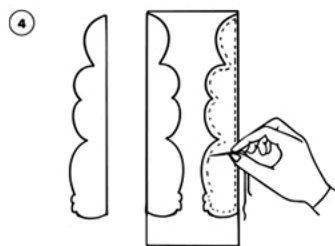

4 Sew the 2 white vinyl pieces onto the clear vinyl rectangle with the straight edges aligned.

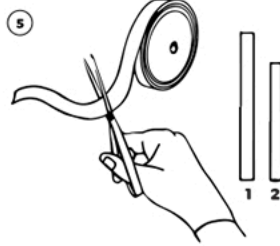

5 Cut 2 pieces of Stretchy Elastic Ribbon. One should be long enough to go under your dog's belly. The other should be long enough to fit across their chest.

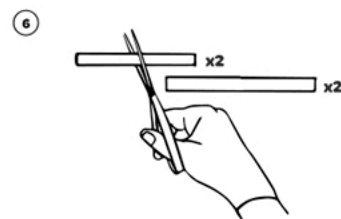

6 Cut each piece in two.

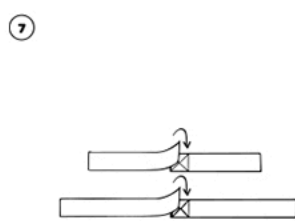

7 Stick them back together using your adhesive velcro.

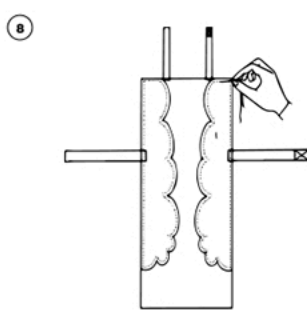

8 Sew the pieces in place on the vinyl rectangle.

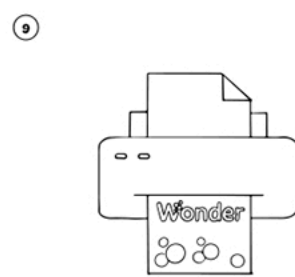

9 Print the Wonder elements on sticker paper

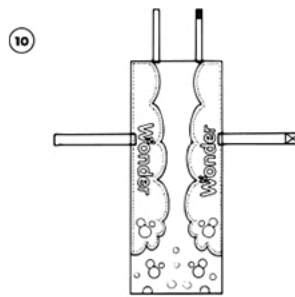

10 Stick the Wonder elements into place.

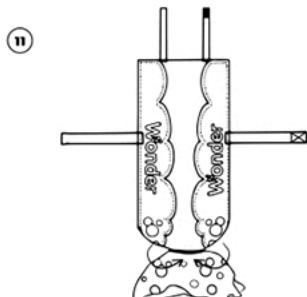

11 Bunch up the tail area and use a white elastic band to secure it.

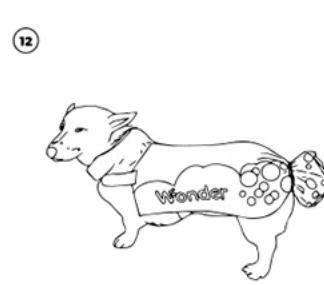

12 Put it on your doggy and enjoy your freshly baked loaf.

What You'll Need

- Clear vinyl
- White vinyl
- Stretchy Elastic Ribbon
- Adhesive Velcro
- Print Friendly Sticker Paper
- Printer
- Sewing Machine (Optional)

